



# Technical Data Sheet

Product range: DOUCHES

Product code: 550

Finishes Available: Chrome

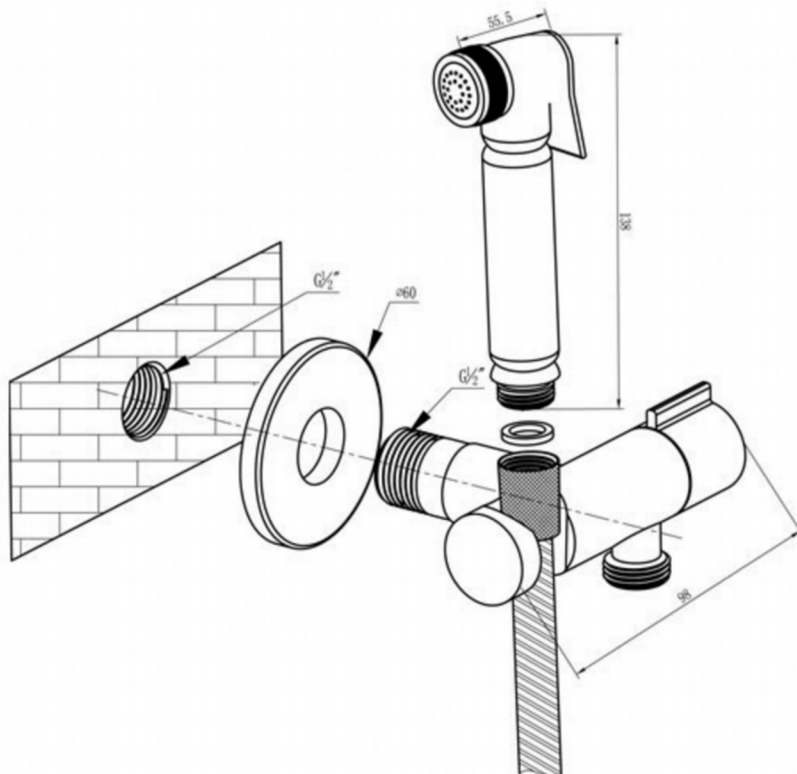

**Min Pressure:**

LP 0.2

**Recommended Max  
Pressure:** 0.5 BAR

**Approvals:**

N/A

**Connections:**

G1/2"

**Warranty:**

15 Years (5 on cartridges)