



Technical Data Sheet

Product range: HUGO

Product code: 71001

Finishes Available: Chrome

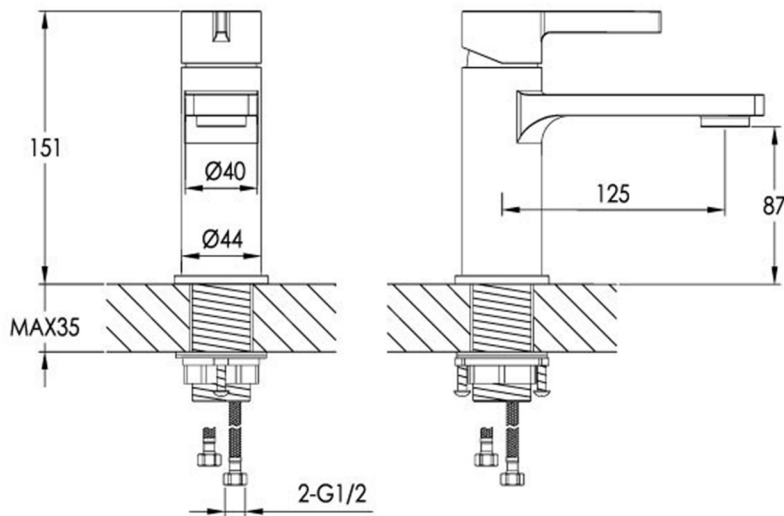

Min Pressure:

LP 0.2

Approvals:

N/A

Connections:

G1/2"

Warranty:

15 Years (5 on cartridges)

Flow Rate