



Technical Data Sheet

Product range: HUGO

Product code: 71025

Finishes Available: Chrome

Min Pressure:

LP 0.2

Approvals:

N/A

Connections:

G1/2"

Warranty:

15 Years (5 on cartridges)

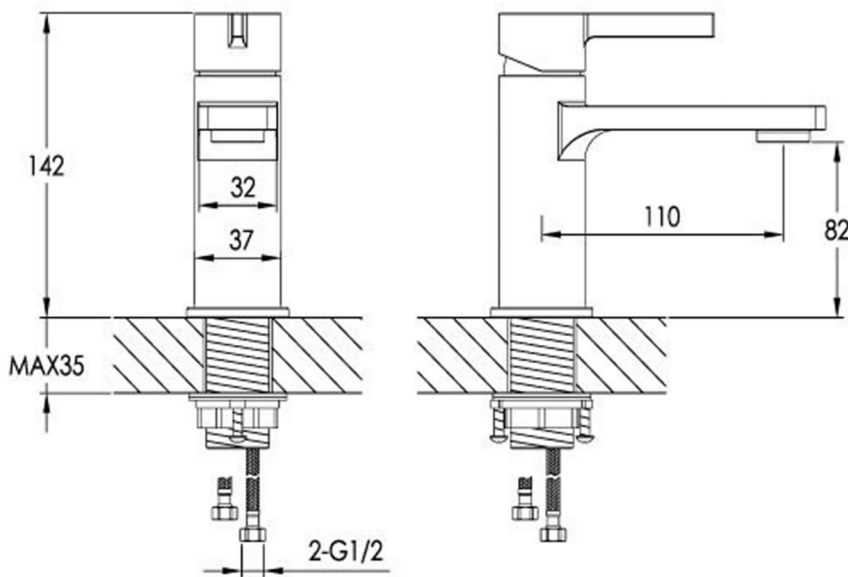

Flow Rate