

Coordinated Bathrooms Designed For You

**Installation & Maintenance Instructions**

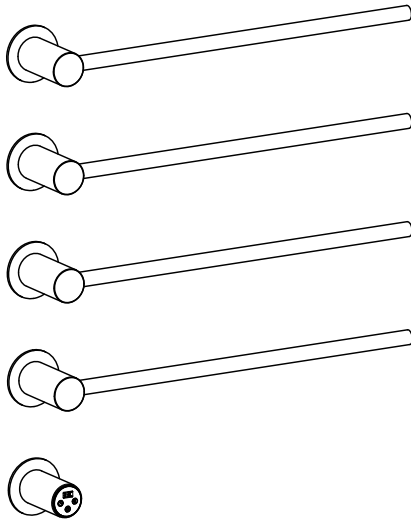

**ONYX ELECTRIC TOWEL RADIATOR 520**

# CONTENTS

<b>Important.....</b>	<b>01</b>
<b>Technical Specification .....</b>	<b>01</b>
<b>Dimension .....</b>	<b>02</b>
<b>Spare Parts .....</b>	<b>03</b>
<b>Installation Steps.....</b>	<b>04</b>
<b>Replacement of control panel.....</b>	<b>09</b>
<b>The guide of the control panel.....</b>	<b>10</b>
<b>Switch on &amp; off .....</b>	<b>11</b>
<b>Timer .....</b>	<b>11</b>
<b>Ajust Temperature .....</b>	<b>11</b>
<b>Test .....</b>	<b>12</b>
<b>Troubleshoot .....</b>	<b>12</b>
<b>Maintenance &amp; Cleaning.....</b>	<b>12</b>

## Important

The product is designed for household or residential use. You are advised to have the product installed by an authorized professional installer. Make sure the product is properly connected to 230V and is earthed.

**WARNING:** This device is not designed to bear the weight of a person, and no one should therefore climb onto it.

This appliance can be used by children aged from 8 years and above and persons with reduced physical sensory or mental capabilities or lack of experience and knowledge if they are supervised or have been given instruction concerning use of the appliance in a safe way and understand the hazards involved. Children should not play with the appliance.

Cleaning and user maintenance should not be carried out by children without supervision. Children must be supervised at all times to ensure that they do not interfere with the product.

## Technical Specification

<b>Frequence</b>	50Hz
<b>Rated power</b>	70W
<b>Votage</b>	AC230V
<b>Heating time</b>	5-10min
<b>Heating temperature</b>	45-60 C
<b>Ingress protection</b>	IP4
<b>Heating method</b>	Dry heating

## Dimension

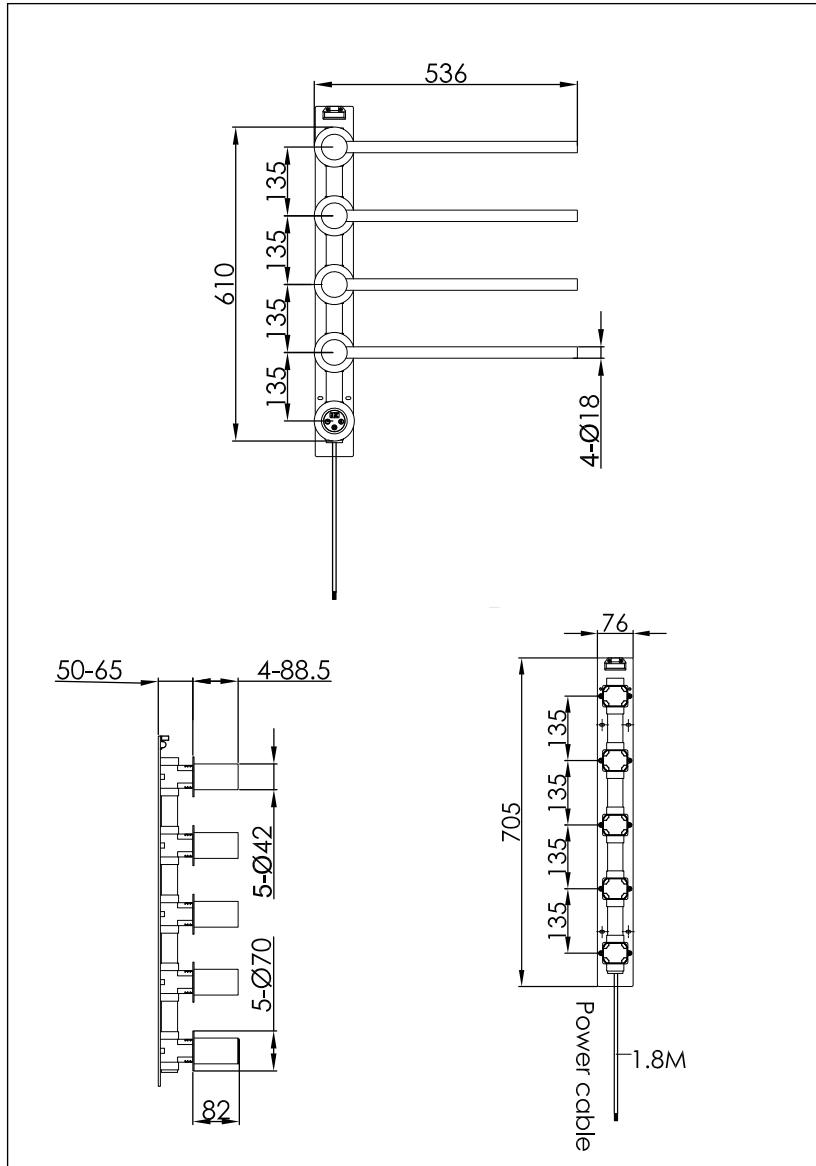

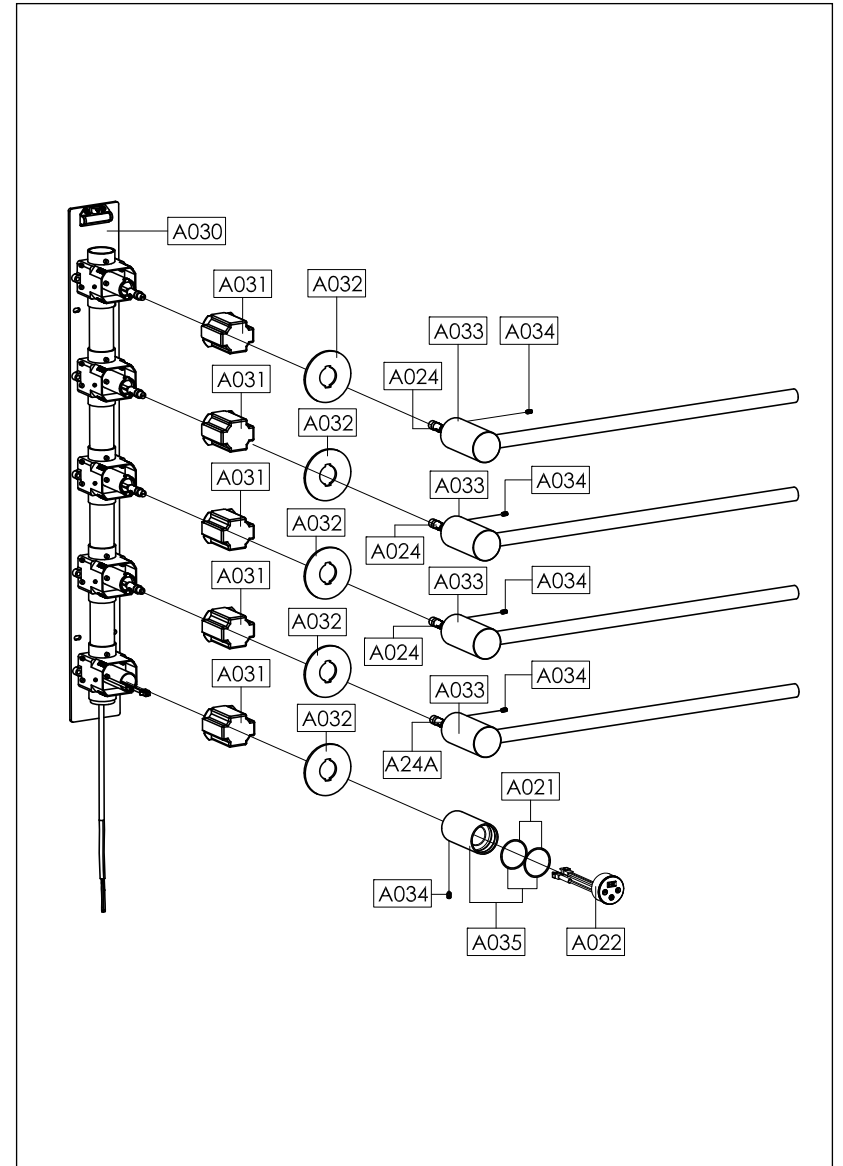

## Spare Parts

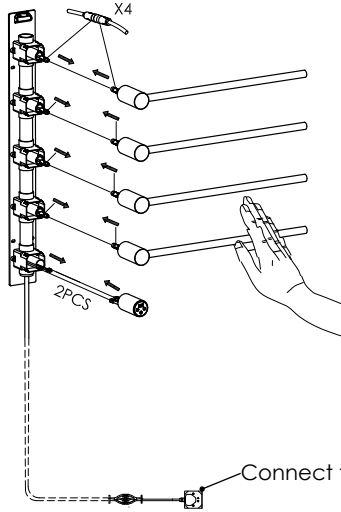

# Installation Steps

**1** **WARNING:** It is recommended that a test installation be carried out as below.



1. Insert the cable in the towel bar into the base as shown.
2. Connect the power cable, press the  button and test for 15-30 minutes.
3. Touch the towel bar lightly with your hand to feel the temperature.
4. Touch the towel bar again at an interval of 30-40 minutes and if the temperature is stable, it is ready for normal use.

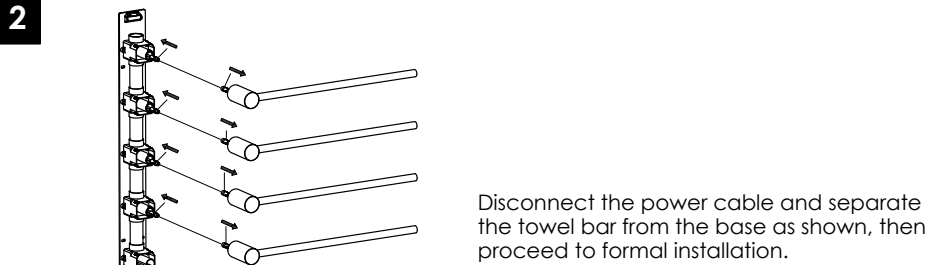

Disconnect the power cable and separate the towel bar from the base as shown, then proceed to formal installation.

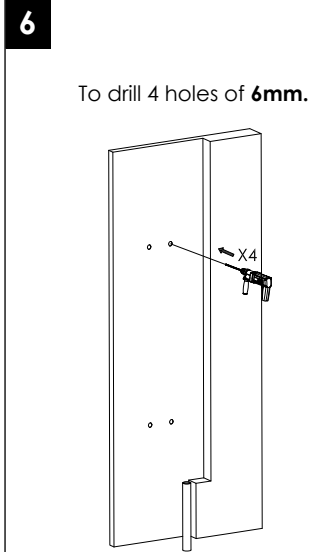
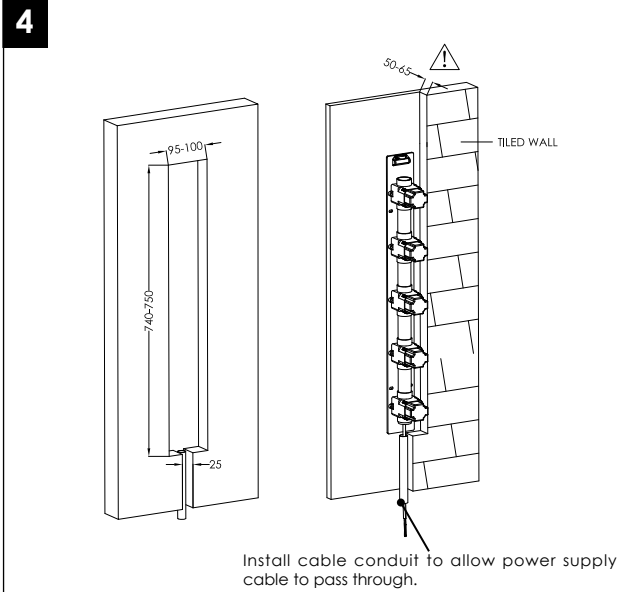
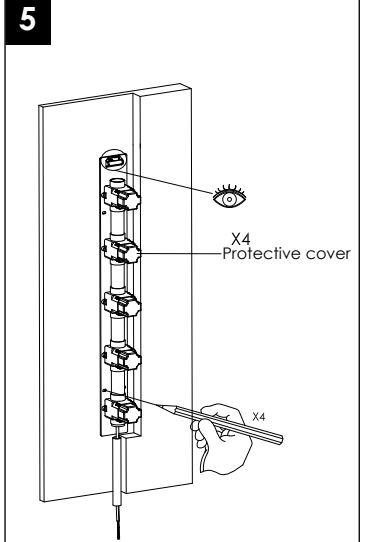
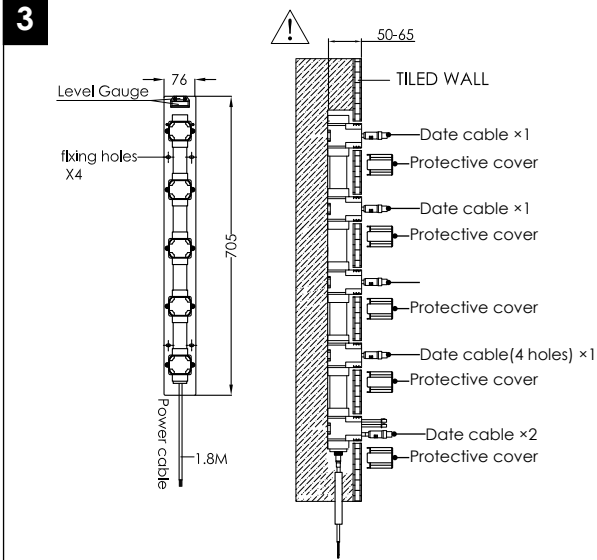



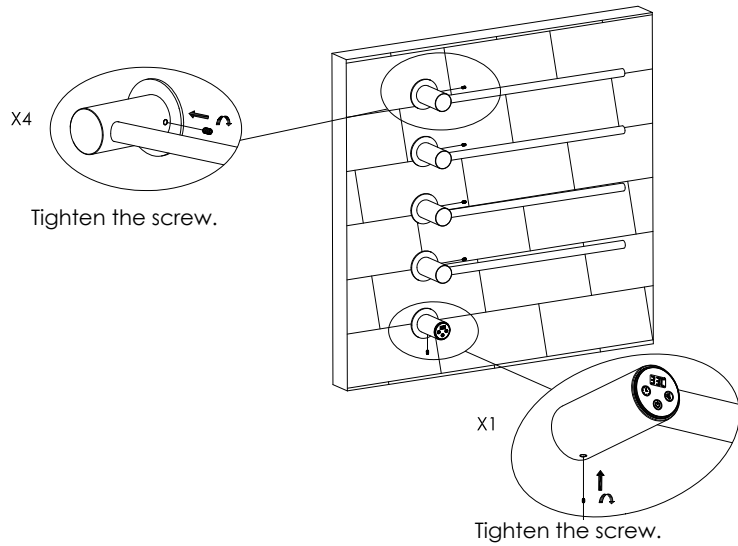

13

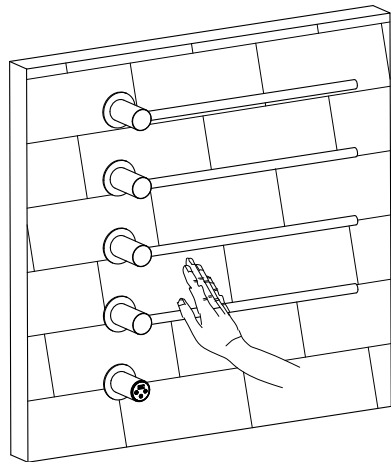

14



-Connect the power cord, press the  button and test for 15-30 minutes.

-Touch the towel bar lightly with your hand to feel the temperature.

-Touch the towel bar again at an interval of 30-40 minutes and if the temperature is stable, it is ready for normal use.

## Replacement of control panel

1

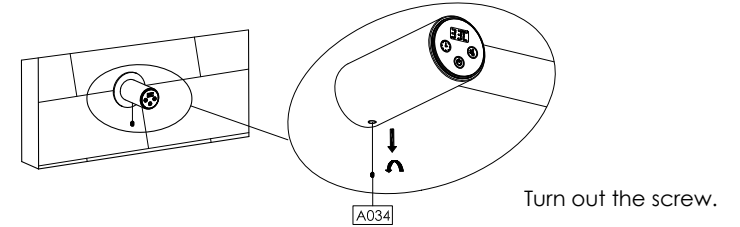

2

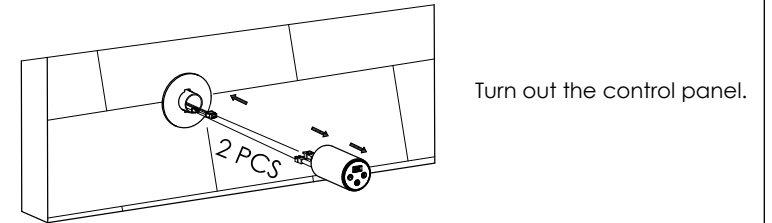

3

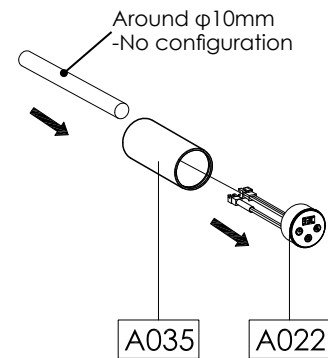

-Thread a tool into A035 and eject the control panel A022.

4

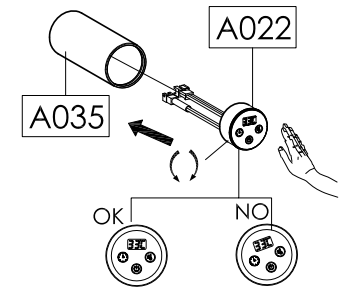

-Press control panel A022 into A035 by hand. Note: Control panel orientation needs to be adjusted.

## The guide of the control panel

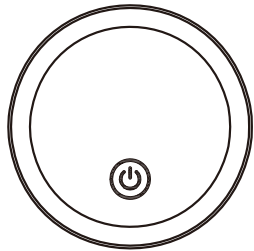



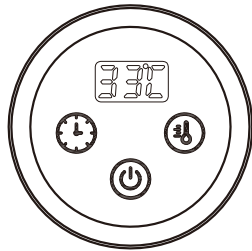

### Stand-by mode

-In stand-by mode, only the  button fade in and out.



### Power-on mode



-Press the  button for one second into power-on mode.

	Screen
	Ajust Temperature
	Timer
	On/Off

## Switch on & off

After connecting the power supply, and the beep sounds into the stand-by mode.

In stand-by mode, press and the  button for 5 seconds to change Celsius or Fahrenheit (factory default is Celsius), the buzzer will ring when the setting is successful.

To switch the product on, please press the  button for one second. To switch the product off, please press the  button for one second again.

## Timer

With the power on, please press the  button to set the timing. Available Timing:1H-2H-3H-4H-5H-6H-7H-8H.

## Adjust Temperature

With the power on, please press the  button to set the temperature.

Available Temperature:45°C (115°F), 50°C (125°F), 55°C (135°F), 60°C (145°F)

With the power on, Press the  button for one second to switch to: real-time temperature/timed time alternating display.

## Test

When an abnormality occurs in the circuit, the chip automatically detects it and displays it on the screen, while the circuit carries out automatic protection to force the radiator to be off.

## Troubleshoot

-Please troubleshoot according to the display on the screen.

EE	No probes were connected
E0	Temperatures below 0°C.
E1	Temperatures above 99°C.

## Maintenance & Cleaning

The product does not require any type of maintenance. We recommend that all parts of the product are kept clean (behind, underneath, upper fins, etc.). Do not use any abrasive product on the steel main body. Clean it with a damp cloth and a pH neutral soap, and the control panel with a dry cloth.

