

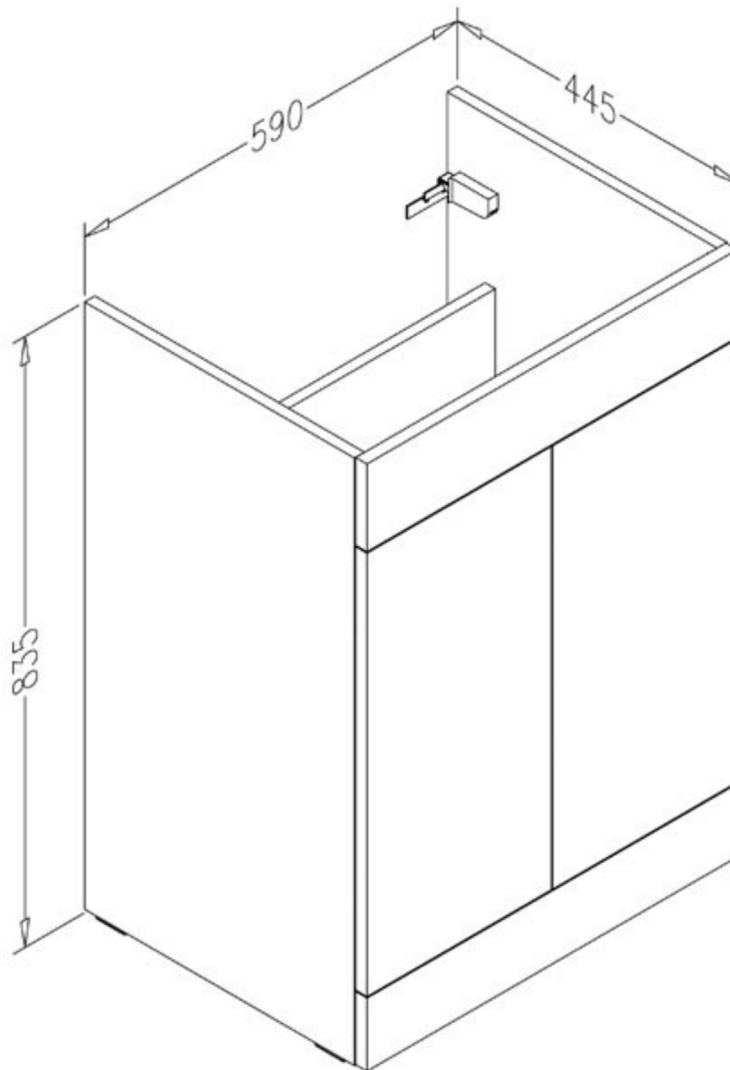

Technical Drawing

Product code: PFS602W+P600BS, PFS602GR+P600BS, PFS602BK+P600BS

Product range: Pace



www.jtpuk.co.uk

technical@jtpuk.co.uk

01895 442211